

Inline™ Manifolds Ordering Information

Mold Mounted Manifolds provide many benefits to the operation and performance of the water cooled process. Our manifolds offer a myriad of combinations to suit your needs.

STANDARD MANIFOLDS

1. Choose your manifold from the following pages.
2. Stock Manifolds will ship same day or by the next business day.

WHEN ORDERING CUSTOM MANIFOLDS

1. Submit design or sketch.
2. Cito will make CAD drawing and submit via fax with price quote and delivery information.
3. Upon approval of drawing, the manifold will be shipped the following week.

TO ORDER YOUR DESIGN KIT FOR INLINE MANIFOLDS

Our Design Kit will assist in your mold or machine mounted design of Inline™ Manifolds — complete with CAD Patterns, and custom order forms.

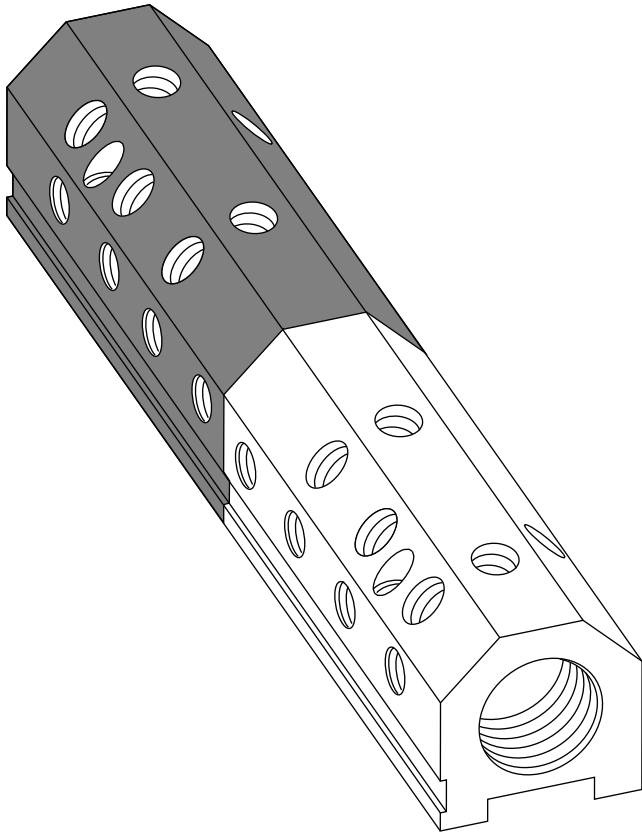

Please contact our Sales Department
CITO PRODUCTS INC.
N8779 County Road X • P.O. Box 90
Watertown, WI 53094 • USA
Phone: (920) 261-2606
Fax: (920) 261-1350
E-mail: sales@pulsecooling.com
ATTENTION: SALES DEPARTMENT

Please specify which CAD system you are using when requesting your Design Kit.

The Design Kit is available in:
.PRT (CadKey)
.DWG (AutoCad)
.DXF (Data Exchange Format)
.IGES (International Graphic Exchange)

The anodized aluminum is not suitable for corrosive liquids (high chlorine content).
Brass, steel and stainless is available. Request quote.

3/4" Inline™ Manifold

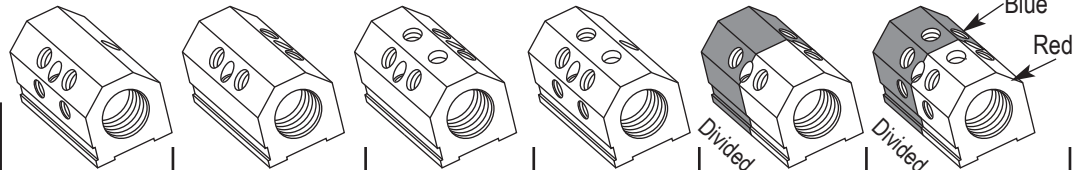
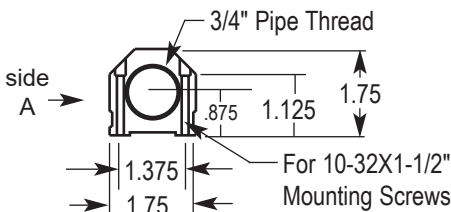
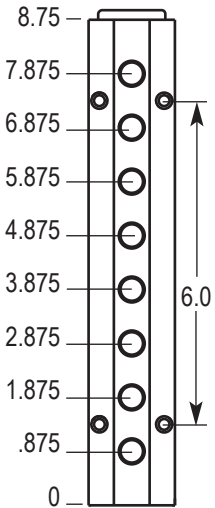
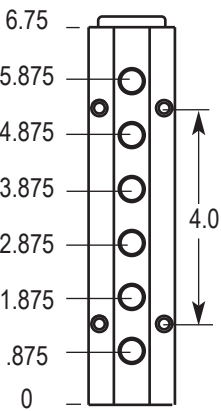
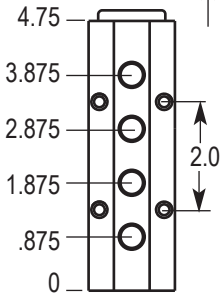
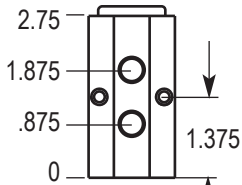

IM3-2-AB-4 1/8 or 1/4 \$45.00
 IM3-2-BD-4 1/8 or 1/4 \$45.00
 IM3-2-BCD-6 1/8 or 1/4 \$51.00
 IM3-2-ABC-6 1/8 or 1/4 \$51.00
 IM3-2-BD-2-2 1/8 or 1/4 \$61.00
 IM3-2-ABCDE-5-5 1/8 \$79.00

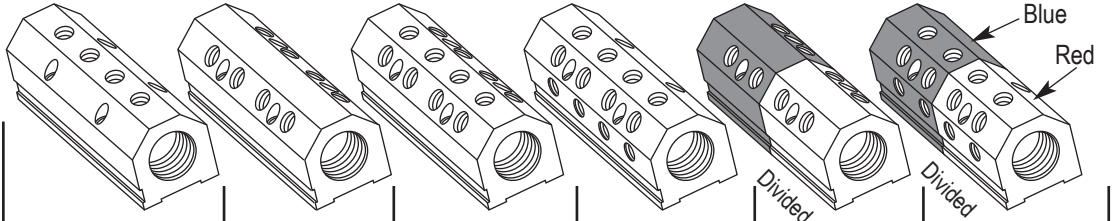

IM3-4-C-4 1/8 or 1/4 \$55.00
 IM3-4-BD-8 1/8 or 1/4 \$67.00
 IM3-4-BCD-12 1/8 or 1/4 \$79.00
 IM3-4-ABC-12 1/8 or 1/4 \$79.00
 IM3-4-BD-4-4 1/8 or 1/4 \$83.00
 IM3-4-ABC-6-6 1/8 or 1/4 \$95.00

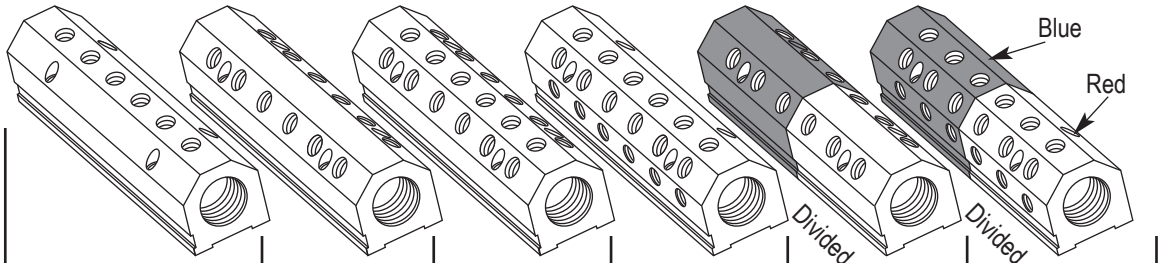

IM3-6-C-6 1/8 or 1/4 \$71.00
 IM3-6-BD-12 1/8 or 1/4 \$89.00
 IM3-6-BCD-18 1/8 or 1/4 \$107.00
 IM3-6-ABC-18 1/8 or 1/4 \$107.00
 IM3-6-BD-6-6 1/8 or 1/4 \$105.00
 IM3-6-ABC-9-9 1/8 or 1/4 \$123.00

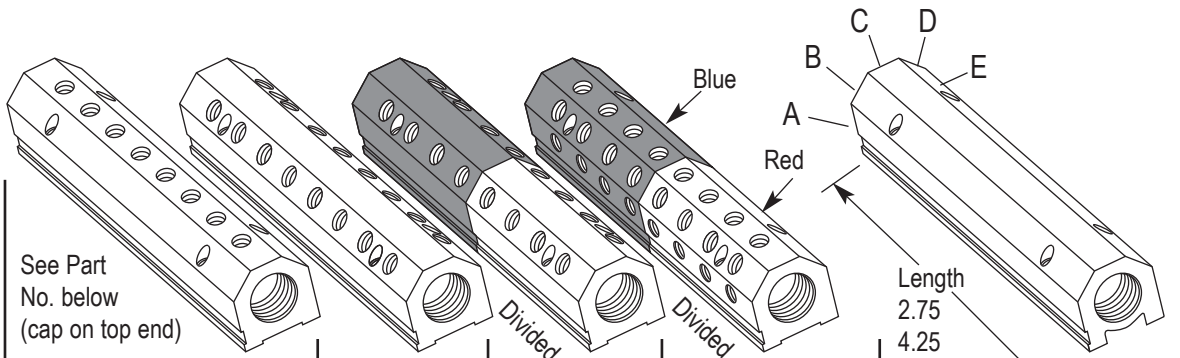

See Part No. below (cap on top end)

IM3-8-C-8 1/8 or 1/4 \$87.00
 IM3-8-BD-16 1/8 or 1/4 \$111.00
 IM3-8-BD-8-8 1/8 or 1/4 \$127.00
 IM3-8-ABC-12-12 1/8 \$151.00

PART NUMBER CODE:

IM3-8-C-8-1/4-N-BLUE

Red, Blue or Divided
 Thread Type: N=NPT
 1/4" "Out"
 8 Holes
 Row on side "C"
 8 = 8.750" Overall Length
 (3) x 1/4" = 3/4" Port
 Inline Manifold

3/4" NPT

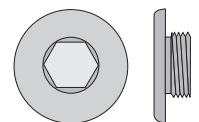

For Solid Color Manifolds
PRICES INCLUDE: End Cap and Stainless mounting screws.
 ADDITIONAL 3/4" MANIFOLD END CAPS: IM-3030 - \$8.00 ea.
CUSTOM MANIFOLDS QUOTED UPON REQUEST

The anodized aluminum is not suitable for corrosive liquids (high chlorine content)

CITO-FP-PRICE-20-1023

1" Inline™ Manifold

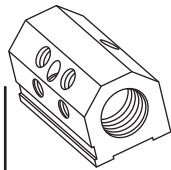
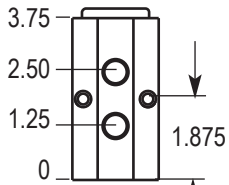

IM4-4-AB-4
1/4 or 3/8
\$58.00

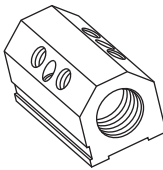

IM4-4-BD-4
1/4 or 3/8
\$58.00

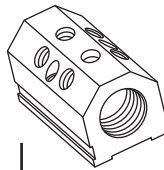

IM4-4-BCD-6
1/4 or 3/8
\$64.00

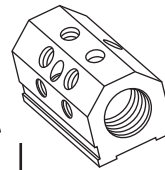

IM4-4-ABC-6
1/4 or 3/8
\$64.00

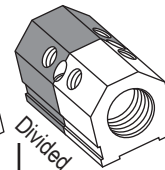

IM4-4-BD-2-2
1/4 or 3/8
\$76.00

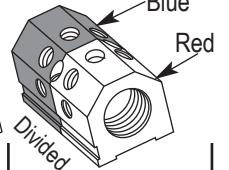

IM4-4-ABCDE-5-5
1/4
\$94.00

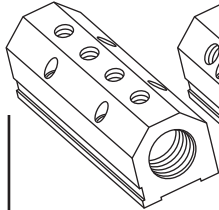
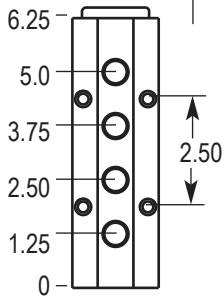

IM4-6-C-4
1/4 or 3/8
\$76.00

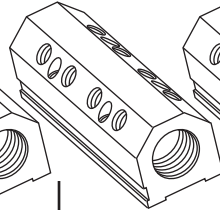

IM4-6-BD-8
1/4 or 3/8
\$88.00

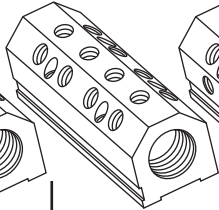

IM4-6-BCD-12
1/4 or 3/8
\$100.00

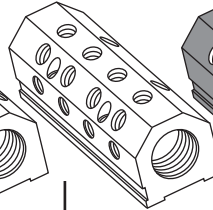

IM4-6-ABC-12
1/4 or 3/8
\$100.00

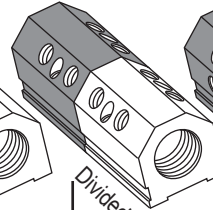

IM4-6-BD-4-4
1/4 or 3/8
\$106.00

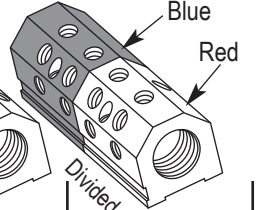

IM4-6-ABC-6-6
1/4 or 3/8
\$118.00

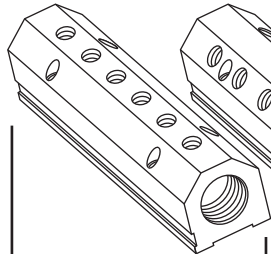
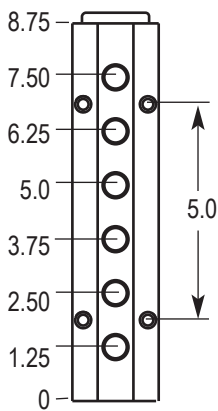

IM4-9-C-6
1/4 or 3/8
\$94.00

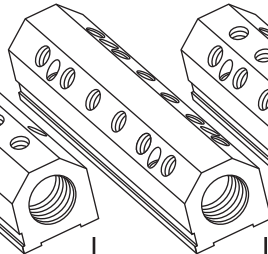

IM4-9-BD-12
1/4 or 3/8
\$112.00

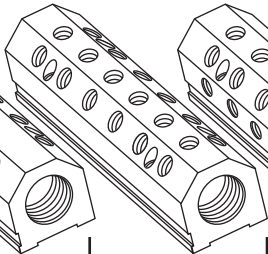

IM4-9-BCD-18
1/4 or 3/8
\$130.00

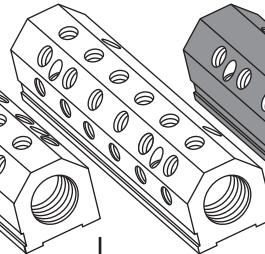

IM4-9-ABC-18
1/4 or 3/8
\$130.00

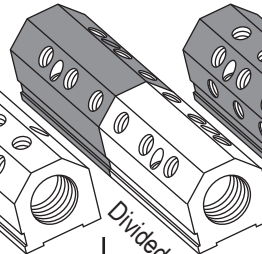

IM4-9-BD-6-6
1/4 or 3/8
\$130.00

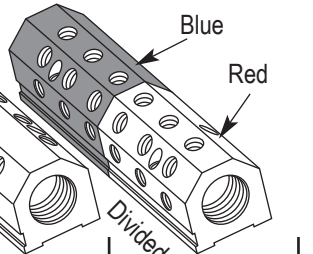

IM4-9-ABC-9-9
1/4 or 3/8
\$148.00

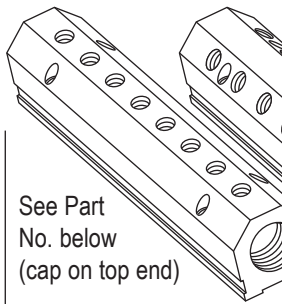
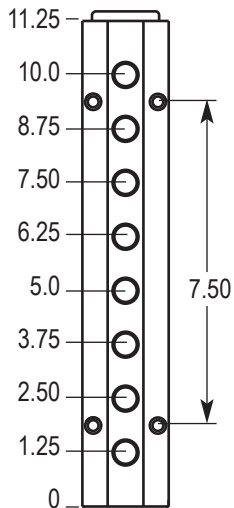

IM4-11-C-8
1/4 or 3/8
\$118.00

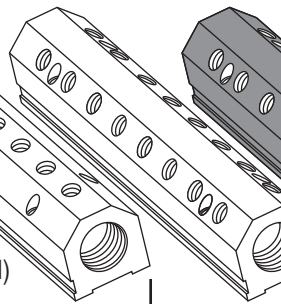

IM4-11-BD-16
1/4 or 3/8
\$142.00

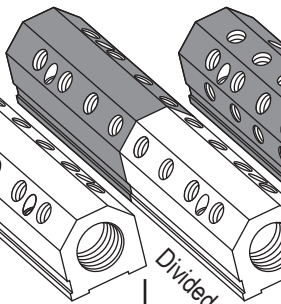

IM4-11-BD-8-8
1/4 or 3/8
\$160.00

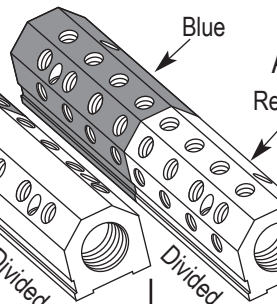

IM4-11-ABC-12-12
1/4 or 3/8
\$184.00

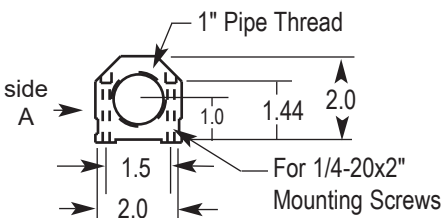
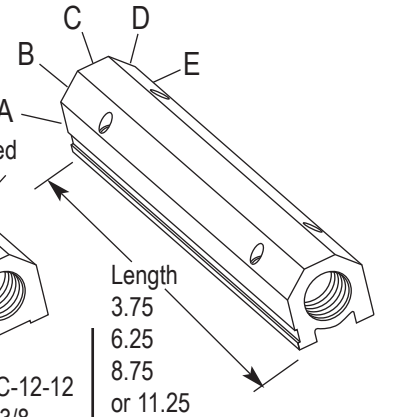

PART NUMBER CODE:

IM4-11-C-8-3/8-N-BLUE

- Red, Blue or Divided
- Thread Type: N=NPT
- P=Mark BSPP
- T=Mark BSPT
- 3/8" "Out"
- 8 Holes
- Row on side "C"
- 11 = 11.25" Overall Length
- (4) x 1/4" = 1" Port

Inline Manifold

1" NPT

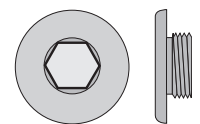

For Solid Color Manifolds
PRICES INCLUDE: End Cap and Stainless mounting screws.
ADDITIONAL 1" MANIFOLD END CAPS: IM-3040 - \$10.00 ea.
CUSTOM MANIFOLDS QUOTED UPON REQUEST

The anodized aluminum is not suitable for corrosive liquids (high chlorine content)

1-1/4" Inline™ Manifold

IM5-5-AB-4 1/4 or 3/8 \$77.00	IM5-5-BD-4 1/4 or 3/8 \$77.00	IM5-5-BCD-6 1/4 or 3/8 \$85.00	IM5-5-ABC-6 1/4 or 3/8 \$85.00	IM5-5-BD-2-2 1/4 or 3/8 \$95.00	IM5-5-ABCDE-5-5 1/4 or 3/8 \$119.00
IM5-8-C-4 1/4 or 3/8 \$98.00	IM5-8-BD-8 1/4 or 3/8 \$114.00	IM5-8-BCD-12 1/4 or 3/8 \$130.00	IM5-8-ABC-12 1/4 or 3/8 \$130.00	IM5-8-BD-4-4 1/4 or 3/8 \$132.00	IM5-8-ABC-6-6 1/4 or 3/8 \$148.00
IM5-11-C-6 1/4 or 3/8 \$127.00	IM5-11-BD-12 1/4 or 3/8 \$151.00	IM5-11-BCD-18 1/4 or 3/8 \$175.00	IM5-11-ABC-18 1/4 or 3/8 \$175.00	IM5-11-BD-6-6 1/4 or 3/8 \$169.00	IM5-11-ABC-9-9 1/4 or 3/8 \$193.00
IM5-14-C-8 1/4 or 3/8 \$156.00	IM5-14-BD-16 1/4 or 3/8 \$188.00	IM5-14-BD-8-8 1/4 or 3/8 \$206.00	IM5-14-ABC-12-12 1/4 or 3/8 \$238.00		

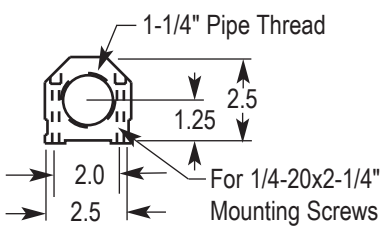

PART NUMBER CODE:
IM5-14-C-8-3/8-N-BLUE

Red, Blue or Divided
 Thread Type: N=NPT
 3/8" "Out"
 P=Mark BSPP
 T=Mark BSPT

8 Holes
 Row on side "C"
 14 = 13.5" Overall Length
 (5) x 1/4" = 1-1/4" Port
 Inline Manifold

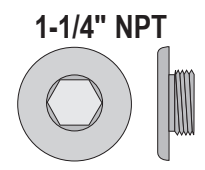

1-1/4" NPT

For Solid Color Manifolds
PRICES INCLUDE: End Cap and
 Stainless mounting screws.
**ADDITIONAL 1-1/4" MANIFOLD END
 CAPS:** IM-3050 - \$12.00 ea.
**CUSTOM MANIFOLDS
 QUOTED UPON REQUEST**

CITO-FP-PRICE-20-1023

The anodized aluminum is not suitable for corrosive liquids (high chlorine content)

1-1/2" Inline™ Manifold

Technical drawings show manifold configurations with dimensions (0 to 18.0 inches) and part numbers. A detailed view shows the manifold end with dimensions: 1-1/2" Pipe Thread, 2.25" mounting hole offset, 3.0" mounting hole spacing, 1.5" hole diameter, 2.0" hole spacing, and 3.0" total width. Mounting holes are for 1/4-20x2-1/2" screws.

Part Number	Thread Type	Price
IM6-6-AB-4	3/8 or 1/2	\$97.00
IM6-6-BD-4	3/8 or 1/2	\$97.00
IM6-6-BCD-6	3/8 or 1/2	\$107.00
IM6-6-ABC-6	3/8 or 1/2	\$107.00
IM6-6-BD-2-2	3/8 or 1/2	\$117.00
IM6-6-ABCDE-5-5	3/8 or 1/2	\$147.00
IM6-10-C-4	3/8 or 1/2	\$129.00
IM6-10-BD-8	3/8 or 1/2	\$149.00
IM6-10-BCD-12	3/8 or 1/2	\$169.00
IM6-10-ABC-12	3/8 or 1/2	\$169.00
IM6-10-BD-4-4	3/8 or 1/2	\$169.00
IM6-10-ABC-6-6	3/8 or 1/2	\$189.00
IM6-14-C-6	3/8 or 1/2	\$171.00
IM6-14-BD-12	3/8 or 1/2	\$201.00
IM6-14-BCD-18	3/8 or 1/2	\$231.00
IM6-14-ABC-18	3/8 or 1/2	\$231.00
IM6-14-BD-6-6	3/8 or 1/2	\$221.00
IM6-14-ABC-9-9	3/8 or 1/2	\$251.00
IM6-18-C-8	3/8 or 1/2	\$213.00
IM6-18-BD-16	3/8 or 1/2	\$253.00
IM6-18-BD-8-8	3/8 or 1/2	\$273.00
IM6-18-ABC-12-12	3/8 or 1/2	\$313.00

PART NUMBER CODE:

IM6-18-C-8-3/8-N-BLUE

Red, Blue or Divided
 Thread Type: N=NPT
 P=Mark BSPP
 T=Mark BSPT
 3/8" "Out"
 8 Holes
 Row on side "C"
 18 = 18" Overall Length
 (6) x 1/4" = 1-1/2" Port
 Inline Manifold

1-1/2" NPT

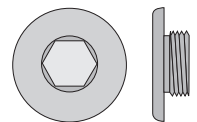

For Solid Color Manifolds
PRICES INCLUDE: End Cap and
 Stainless mounting screws.
 ADDITIONAL 1-1/2" MANIFOLD END
 CAPS: IM-3060 - \$14.00 ea.
CUSTOM MANIFOLDS
QUOTED UPON REQUEST

CITO-FP-PRICE-20-1023

The anodized aluminum is not suitable for corrosive liquids (high chlorine content)

2" Inline™ Manifold

IM8-8-ACE-6
1/2, 3/4 or 1
\$144.00

IM8-8-ABCDE-10
1/2 or 3/4
\$168.00

IM8-12-C-4
1/2, 3/4 or 1
\$168.00

IM8-12-BD-8
1/2, 3/4 or 1
\$192.00

IM8-12-ABC-12
1/2 or 3/4
\$216.00

IM8-12-ABC-6-6
1/2 or 3/4
\$242.00

IM8-17-C-6
1/2, 3/4 or 1
\$225.00

IM8-17-BD-12
1/2, 3/4 or 1
\$261.00

IM8-17-ABC-18
1/2 or 3/4
\$297.00

IM8-17-BD-6-6
1/2, 3/4 or 1
\$287.00

IM8-17-ABC-9-9
1/2 or 3/4
\$323.00

IM8-22-C-8
1/2, 3/4 or 1
\$282.00

IM8-22-BD-16
1/2, 3/4 or 1
\$330.00

IM8-22-BD-8-8
1/2, 3/4 or 1
\$356.00

IM8-22-ABC-12-12
1/2 or 3/4
\$404.00

PART NUMBER CODE:
IM8-22-C-6-1/2-N-BLUE

- Red, Blue or Divided
- Thread Type: N=NPT
- P=Mark BSPP
- T=Mark BSPT
- 1/2" "Out"
- 6 Holes
- Row on side "C"
- 22 = 22" Overall Length
- (8) x 1/4" = 2" Port

2" NPT

For Solid Color Manifolds
PRICES INCLUDE: End Cap and Stainless mounting screws.
ADDITIONAL 2" MANIFOLD END CAPS: IM-3080 - \$16.00 ea.
CUSTOM MANIFOLDS QUOTED UPON REQUEST

CITO-FP-PRICE-20-1023

The anodized aluminum is not suitable for corrosive liquids (high chlorine content)

3/4" x 5" Sideline™ Manifold

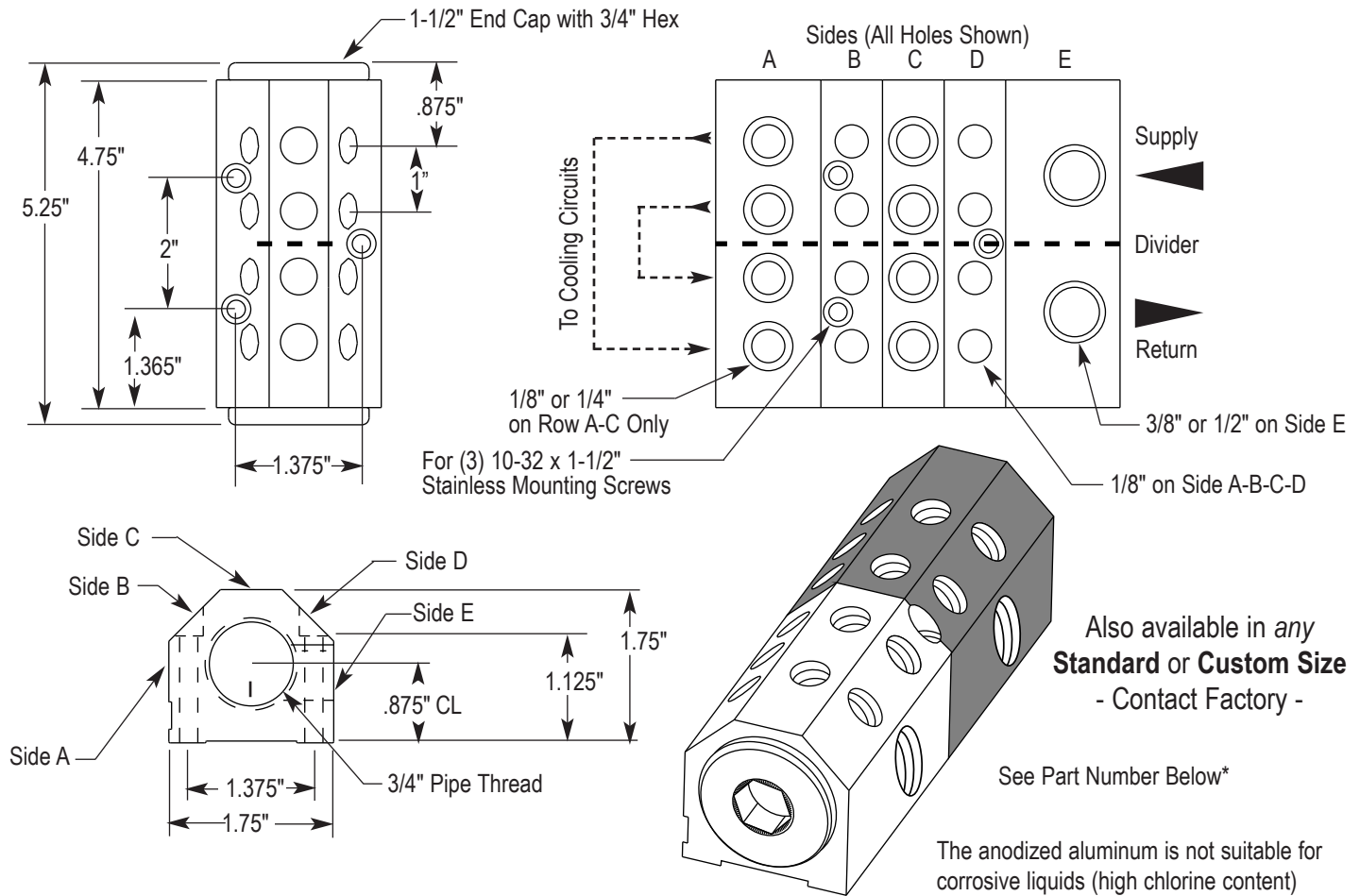

Outgoing Ports					Part Number	Price
Side A In/Out	Side B In/Out	Side C In/Out	Side D In/Out	Side E - Return In/Out		
	(2) (2) 1/8"-1/8"			3/8"-3/8"	IM3S-5-3/8-B-2-2-1/8-N-R/B	\$93.00
(2) (2) 1/8"-1/8"	(2) (2) 1/8"-1/8"			3/8"-3/8"	IM3S-5-3/8-AB-4-4-1/8-N-R/B	\$105.00
	(2) (2) 1/8"-1/8"		(2) (2) 1/8"-1/8"	3/8"-3/8"	*IM3S-5-3/8-BD-4-4-1/8-N-R/B	\$105.00
	(2) (2) 1/8"-1/8"	(2) (2) 1/8"-1/8"	(2) (2) 1/8"-1/8"	3/8"-3/8"	IM3S-5-3/8-BCD-6-6-1/8-N-R/B	\$117.00
(2) (2) 1/8"-1/8"	(2) (2) 1/8"-1/8"	(2) (2) 1/8"-1/8"	(2) (2) 1/8"-1/8"	3/8"-3/8"	IM3S-5-3/8-ABCD-8-8-1/8-N-R/B	\$129.00
	(2) (2) 1/4"-1/4"			1/2"-1/2"	IM3S-5-1/2-B-2-2-1/4-N-R/B	\$93.00
	(2) (2) 1/4"-1/4"		(2) (2) 1/4"-1/4"	1/2"-1/2"	IM3S-5-1/2-BD-4-4-1/4-N-R/B	\$105.00

PRICE INCLUDES: End Caps and (3) 10-32 x 1-1/2" ST. ST. Mtg. Screws. ADDITIONAL 3/4" End Caps \$8.00 ea.

*Part Number Code:

IM3S-5-3/8-BD-4-4-1/8-N-R/B

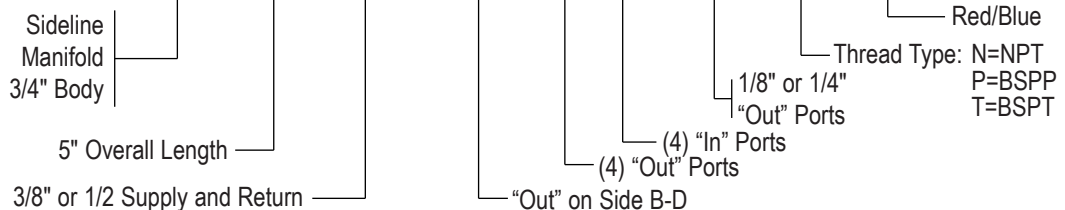

CITO-FP-PRICE-20-1023

1" x 7" Sideline™ Manifold

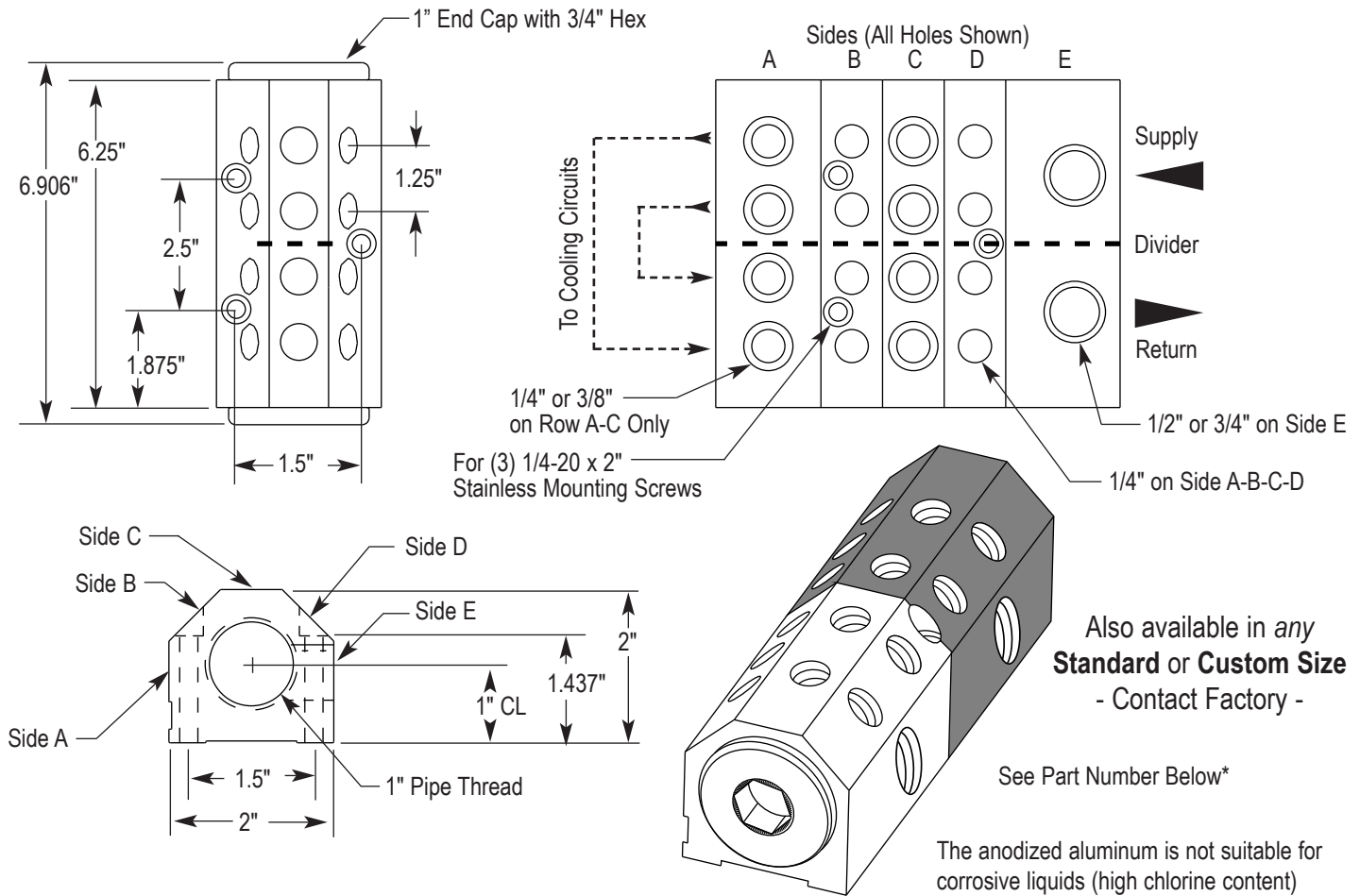

Outgoing Ports					Part Number	Price
Side A In/Out	Side B In/Out	Side C In/Out	Side D In/Out	Side E - Return In/Out		
	(2) (2) 1/4"-1/4"			1/2"-1/2"	IM4S-7-1/2-B-2-2-1/4-N-R/B	\$120.00
(2) (2) 1/4"-1/4"	(2) (2) 1/4"-1/4"			1/2"-1/2"	IM4S-7-1/2-AB-4-4-1/4-N-R/B	\$132.00
	(2) (2) 1/4"-1/4"		(2) (2) 1/4"-1/4"	1/2"-1/2"	IM4S-7-1/2-BD-4-4-1/4-N-R/B	\$132.00
	(2) (2) 1/4"-1/4"	(2) (2) 1/4"-1/4"	(2) (2) 1/4"-1/4"	1/2"-1/2"	*IM4S-7-1/2-BCD-6-6-1/4-N-R/B	\$144.00
(2) (2) 1/4"-1/4"	(2) (2) 1/4"-1/4"	(2) (2) 1/4"-1/4"	(2) (2) 1/4"-1/4"	1/2"-1/2"	IM4S-7-1/2-ABCD-8-8-1/4-N-R/B	\$156.00
	(2) (2) 3/8"-3/8"			3/4"-3/4"	IM4S-7-3/4-B-2-2-3/8-N-R/B	\$120.00
	(2) (2) 3/8"-3/8"		(2) (2) 3/8"-3/8"	3/4"-3/4"	IM4S-7-3/4-BD-4-4-3/8-N-R/B	\$132.00

PRICE INCLUDES: End Caps and (3) 1/4-20x2" ST. ST. Mtg. Screws. ADDITIONAL 1" End Caps \$10.00 ea.

*Part Number Code:

IM4S-7-1/2-BCD-6-6-1/4-N-R/B

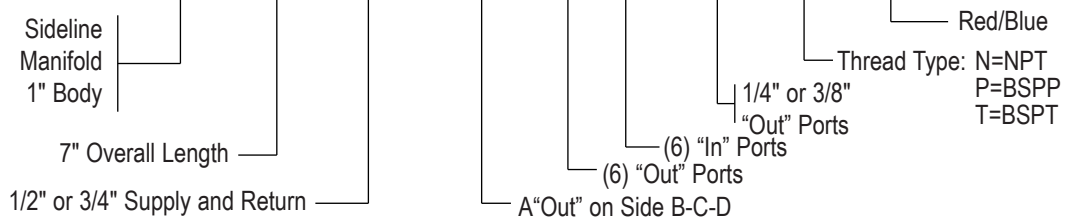

CITO-FP-PRICE-20-1023

1-1/4" x 8" Sideline™ Manifold

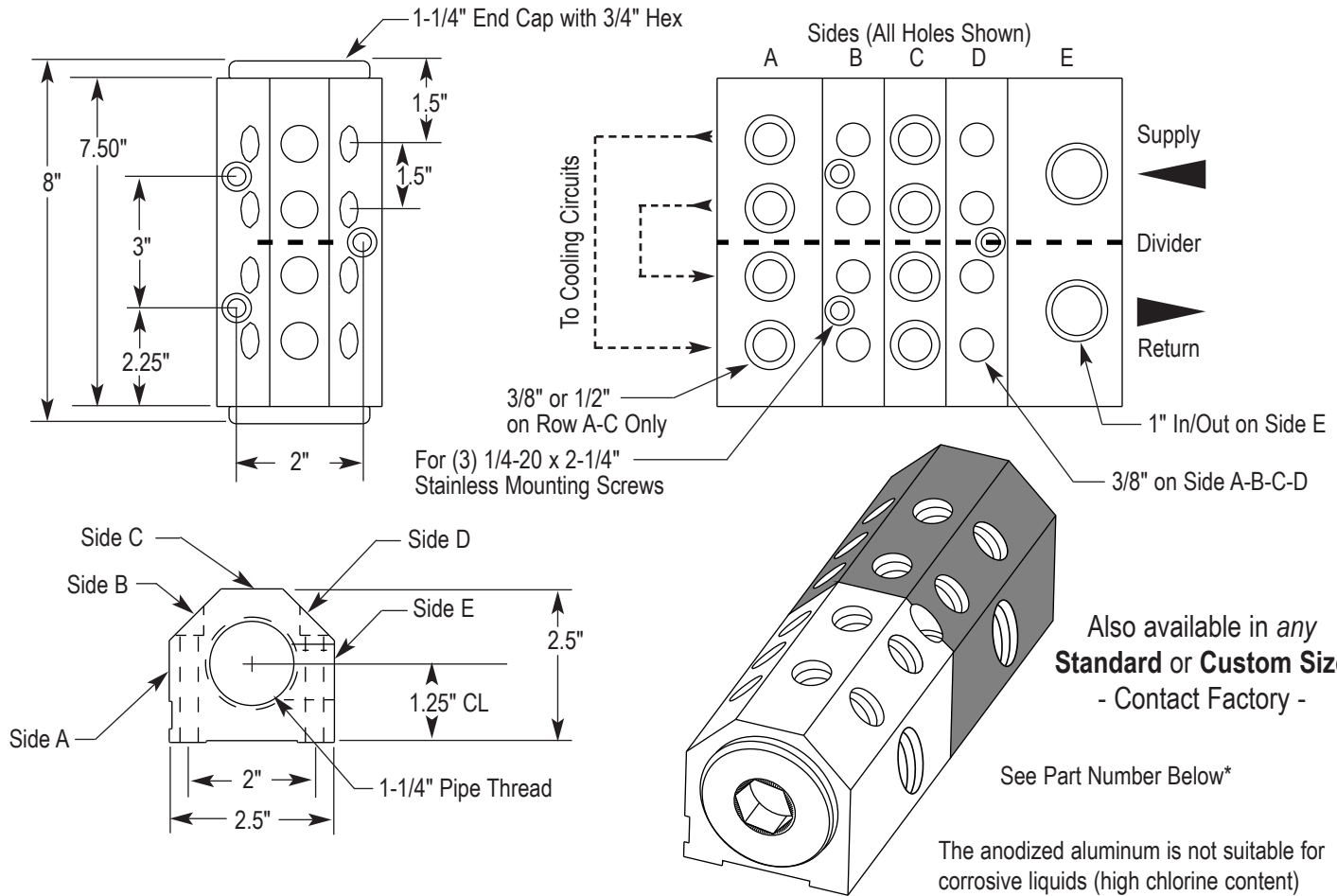

Outgoing Ports					Part Number	Price
Side A In/Out	Side B In/Out	Side C In/Out	Side D In/Out	Side E - Return In/Out		
	(2) (2) 3/8"-3/8"			1"-1"	IM5S-8-1-B-2-2-3/8-N-R/B	\$148.00
(2) (2) 3/8"-3/8"	(2) (2) 3/8"-3/8"			1"-1"	IM5S-8-1-AB-4-4-3/8-N-R/B	\$164.00
	(2) (2) 3/8"-3/8"		(2) (2) 3/8"-3/8"	1"-1"	IM5S-8-1-BD-4-4-3/8-N-R/B	\$164.00
	(2) (2) 3/8"-3/8"	(2) (2) 3/8"-3/8"	(2) (2) 3/8"-3/8"	1"-1"	IM5S-8-1-ABC-6-6-3/8-N-R/B	\$180.00
(2) (2) 3/8"-3/8"	(2) (2) 3/8"-3/8"	(2) (2) 3/8"-3/8"	(2) (2) 3/8"-3/8"	1"-1"	*IM5S-8-1-ABCD-8-8-3/8-N-R/B	\$196.00
	(2) (2) 1/2"-1/2"			1"-1"	IM5S-8-1-B-2-2-1/2-N-R/B	\$148.00
	(2) (2) 1/2"-1/2"		(2) (2) 1/2"-1/2"	1"-1"	IM5S-8-1-BD-4-4-1/2-N-R/B	\$164.00

PRICE INCLUDES: End Caps and (3) 1/4-20 x 2-1/4" ST. ST. Mtg. Screws. ADDITIONAL 1-1/4" End Caps \$12.00 ea.

*Part Number Code:

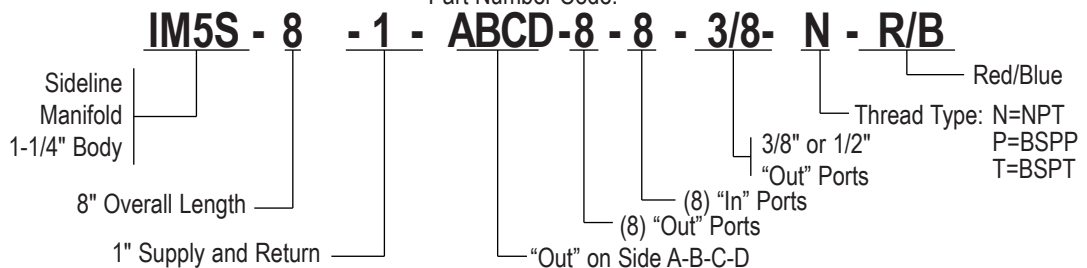

CITO-FP-PRICE-20-1023

1-1/2" x 10" Sideline™ Manifold

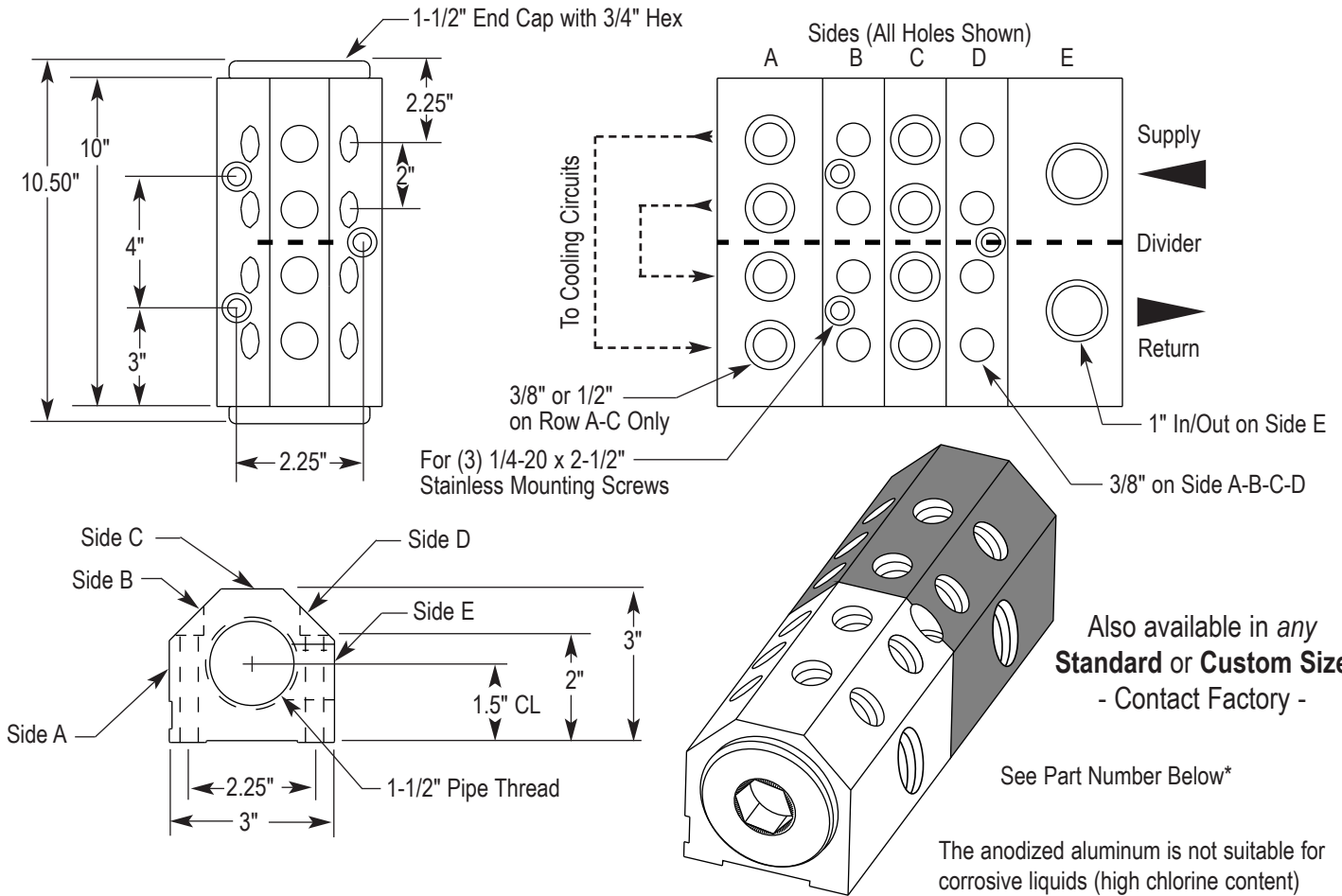

Outgoing Ports					Part Number	Price
Side A In/Out	Side B In/Out	Side C In/Out	Side D In/Out	Side E - Return In/Out		
	(2) (2) 3/8"-3/8"			1"-1"	IM6S-10-1-B-2-2-3/8-N-R/B	\$187.00
(2) (2) 3/8"-3/8"	(2) (2) 3/8"-3/8"			1"-1"	IM6S-10-1-AB-4-4-3/8-N-R/B	\$207.00
	(2) (2) 3/8"-3/8"		(2) (2) 3/8"-3/8"	1"-1"	IM6S-10-1-BD-4-4-3/8-N-R/B	\$207.00
	(2) (2) 3/8"-3/8"	(2) (2) 3/8"-3/8"	(2) (2) 3/8"-3/8"	1"-1"	IM6S-10-1-ABC-6-6-3/8-N-R/B	\$227.00
(2) (2) 3/8"-3/8"	(2) (2) 3/8"-3/8"	(2) (2) 3/8"-3/8"	(2) (2) 3/8"-3/8"	1"-1"	*IM6S-10-1-ABCD-8-8-3/8-N-R/B	\$247.00
	(2) (2) 1/2"-1/2"			1"-1"	IM6S-10-1-B-2-2-1/2-N-R/B	\$187.00
	(2) (2) 1/2"-1/2"		(2) (2) 1/2"-1/2"	1"-1"	IM6S-10-1-BD-4-4-1/2-N-R/B	\$207.00

PRICE INCLUDES: End Caps and (3) 1/4-20 x 2-1/2" ST. ST. Mtg. Screws. ADDITIONAL 1-1/2" End Caps \$14.00 ea.

*Part Number Code:

IM6S - 10 - 1 - ABCD - 8 - 8 - 3/8 - N - R/B

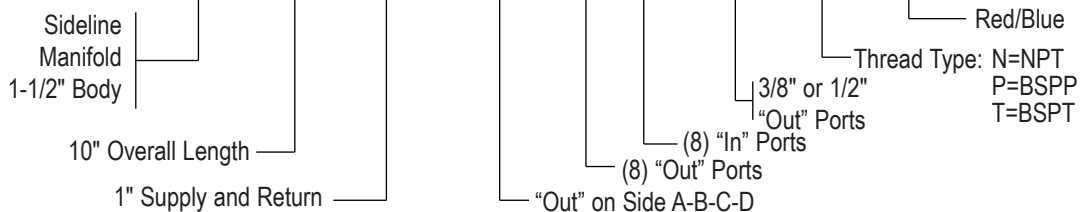

CITO-FP-PRICE-20-1023

2" x 12" Sideline™ Manifold

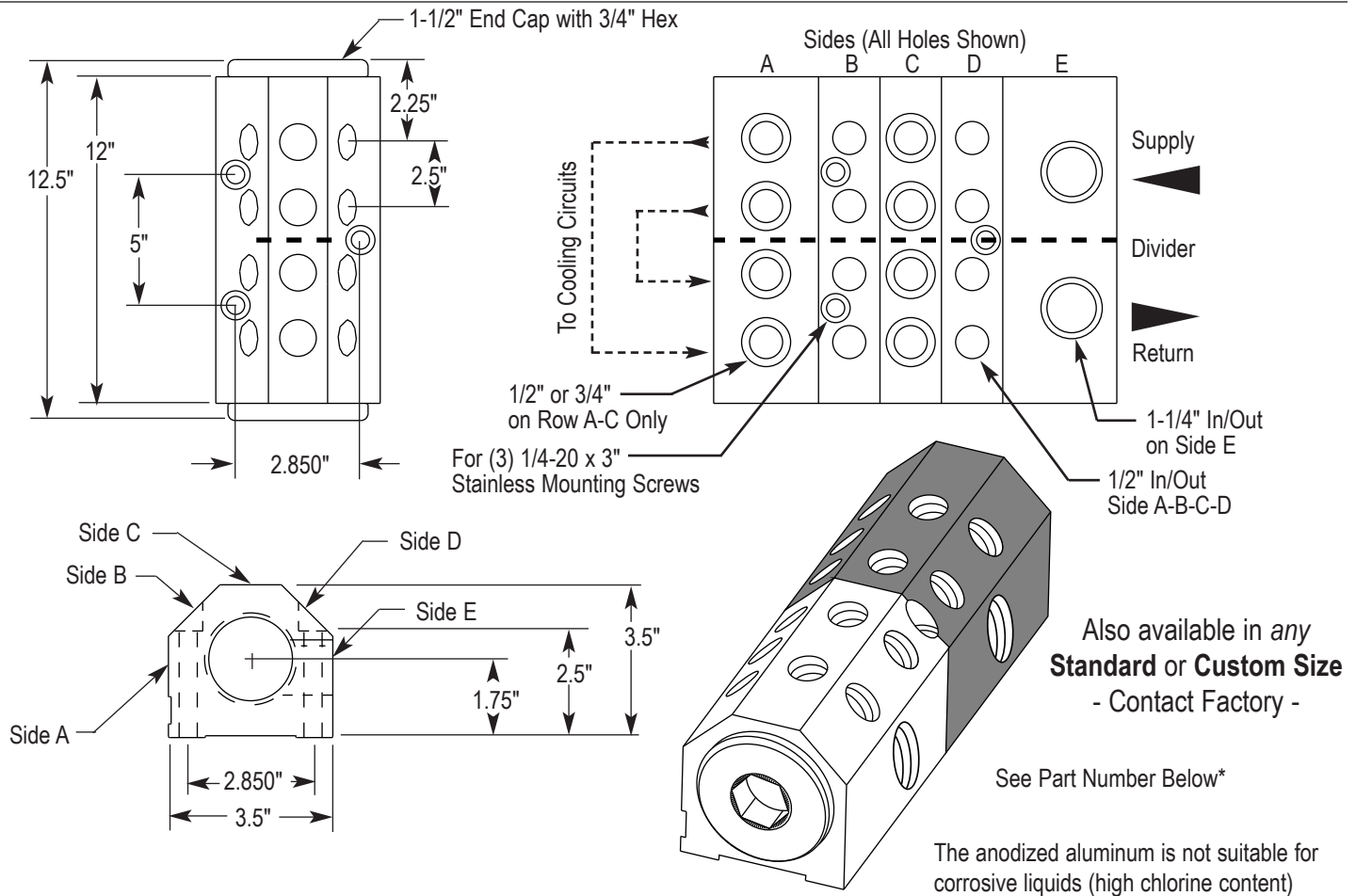

Outgoing Ports					Part Number	Price
Side A In/Out	Side B In/Out	Side C In/Out	Side D In/Out	Side E - Return In/Out		
	(2) (2) 1/2"-1/2"			1-1/4"-1-1/4"	IM8S-12-1-1/4-B-2-2-1/2-N-R/B	\$238.00
(2) (2) 1/2"-1/2"	(2) (2) 1/2"-1/2"			1-1/4"-1-1/4"	IM8S-12-1-1/4-AB-4-4-1/2-N-R/B	\$262.00
	(2) (2) 1/2"-1/2"		(2) (2) 1/2"-1/2"	1-1/4"-1-1/4"	IM8S-12-1-1/4-BD-4-4-1/2-N-R/B	\$262.00
	(2) (2) 1/2"-1/2"	(2) (2) 1/2"-1/2"	(2) (2) 1/2"-1/2"	1-1/4"-1-1/4"	IM8S-12-1-1/4-BCD-6-6-1/2-N-R/B	\$286.00
(2) (2) 1/2"-1/2"	(2) (2) 1/2"-1/2"	(2) (2) 1/2"-1/2"	(2) (2) 1/2"-1/2"	1-1/4"-1-1/4"	*IM8S-12-1-1/4-ABCD-8-8-1/2-N-R/B	\$310.00
	(2) (2) 3/4"-3/4"			1-1/4"-1-1/4"	IM8S-12-1-1/4-B-2-2-3/4-N-R/B	\$238.00
	(2) (2) 3/4"-3/4"		(2) (2) 3/4"-3/4"	1-1/4"-1-1/4"	IM8S-12-1-1/4-BD-4-4-3/4-N-R/B	\$262.00

PRICE INCLUDES: End Caps and 1/4" - 20 x 3" ST. ST. Mtg. Screws. ADDITIONAL 2" End Caps \$16.00 ea.

*Part Number Code: **IM8S-12-1-1/4-ABCD-8-8-3/8-N-R/B**

Sideline Manifold 2" Body
 12" Long Overall Length
 1-1/4" Supply and Return
 (8) "In" Ports
 (8) "Out" Ports
 "Out" on Side A-B-C-D
 3/8", 1/2" or 3/4" "Out" Ports
 Thread Type: N=NPT, P=BSPP, T=BSPT
 Red/Blue

CITO-FP-PRICE-20-1023

BottomLine™ Custom Mold Mounted Manifold

Submit your requirements for pricing
and delivery
CITO PRODUCTS INC.
ATTENTION: SALES DEPARTMENT

CITO will submit drawing
and assign part number
for all models

3/4" IM3

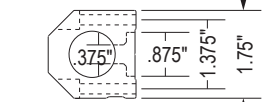

3/8" Hole Diameter
310 "O" Ring
ORDER # IMBL-3XX

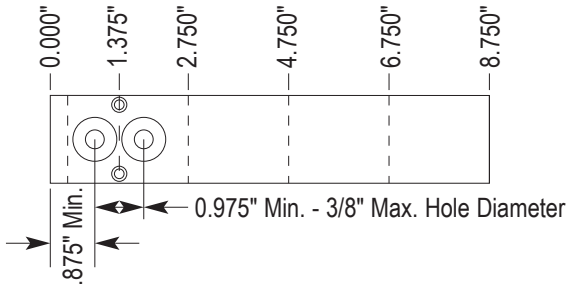

1" IM4

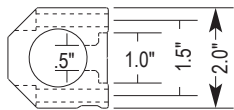

1/2" Hole Diameter
312 "O" Ring
ORDER # IMBL-4XX

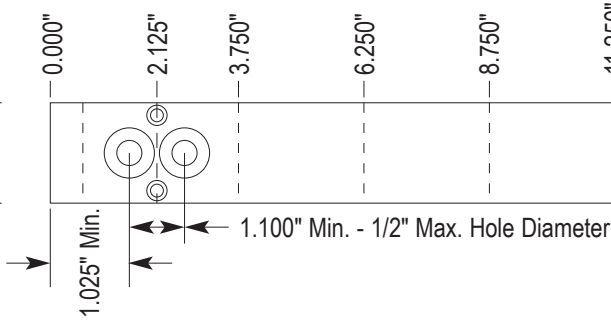

1-1/4" IM5

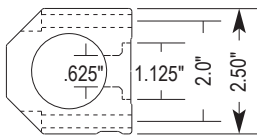

5/8" Hole Diameter
314 "O" Ring
ORDER # IMBL-5XX

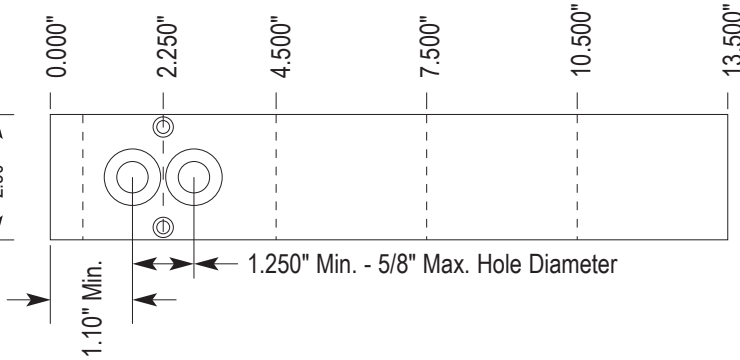

1-1/2" IM6

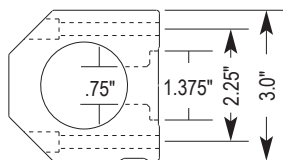

3/4" Hole Diameter
318 "O" Ring
ORDER # IMBL-6XX

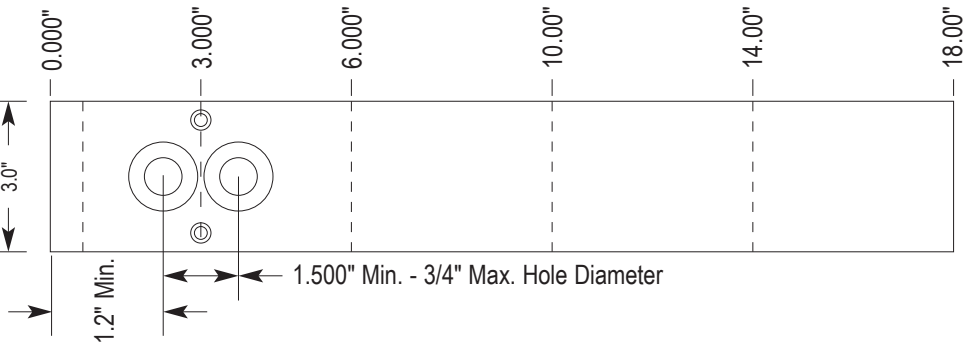

2" IM8

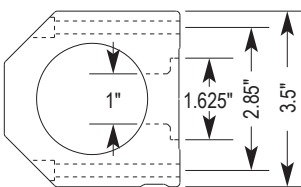

1" Hole Diameter
322 "O" Ring
ORDER # IMBL-8XX

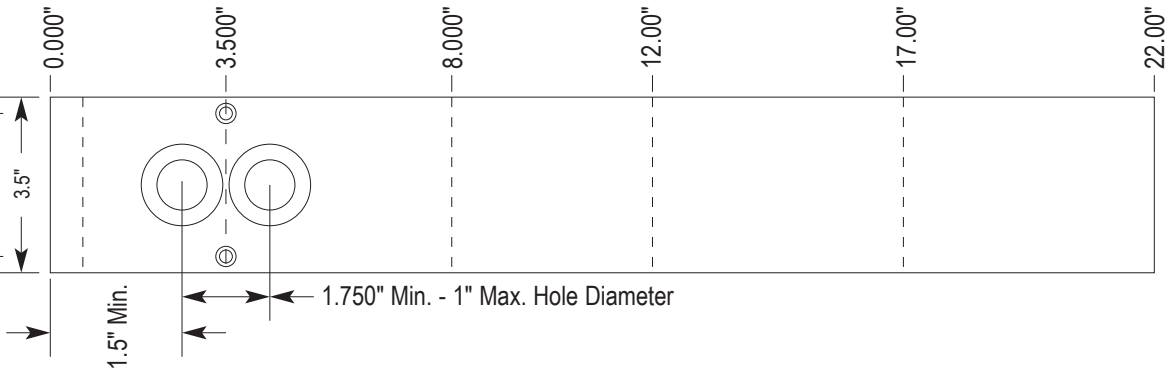

CITO-FP-PRICE-20-1023

RotoLine™ Flow Indicating Manifold

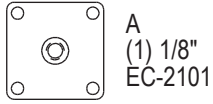

A
(1) 1/8"
EC-2101

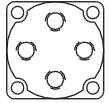

B
(4) 1/8"
EC-2104

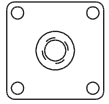

C
(1) 1/4"
EC-2201

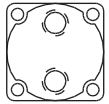

D
(2) 1/4"
EC-2202

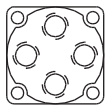

E
(4) 1/4"
EC-2204

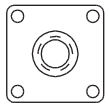

F
(1) 3/8"
EC-2301

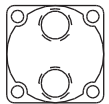

G
(2) 3/8"
EC-2302

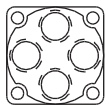

H
(4) 3/8"
EC-2304

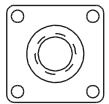

K
(1) 1/2"
EC-2401

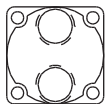

M
(2) 1/2"
EC-2402

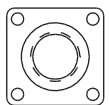

N
(1) 3/4"
EC-2601

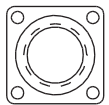

P
(1) 1"
EC-2801



R
(1) 1-1/4"
EC-2051

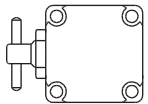

Valve Cap
1/4" (S)
VC-2902

3/8" (T)
VC-2903

1/2" (U)
VC-2904

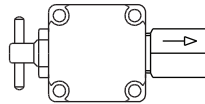

Valve Cap with Check Valve:
1/4" (V) CC-2902
3/8" (W) CC-2903
1/2" (X) CC-2904



1/4" Check Valve
CV-1202-MF

3/8" Check Valve
CV-1203-MF

1/2" Check Valve
CV-1204-MF

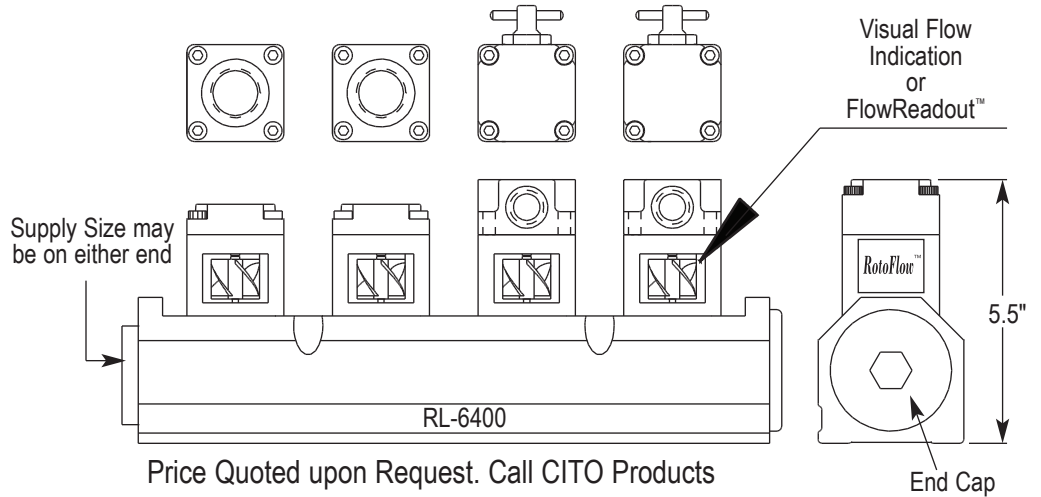
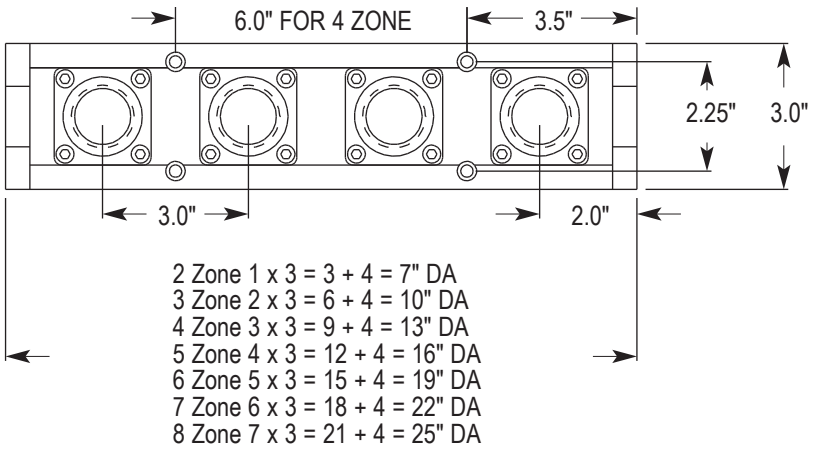

RL6 - 4 - N - R - 01

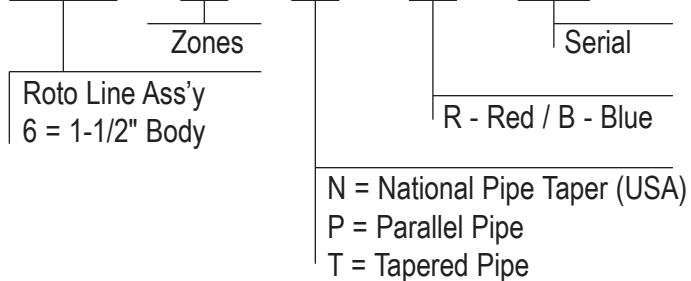

CITO PRODUCTS

WILL ASSIGN MODEL NUMBER TO EACH CUSTOM ASSEMBLY

CITO-FP-PRICE-20-1023

Flow Considerations

Flow Restriction (or Unbalanced) Hook Ups Will Increase Cycle Time

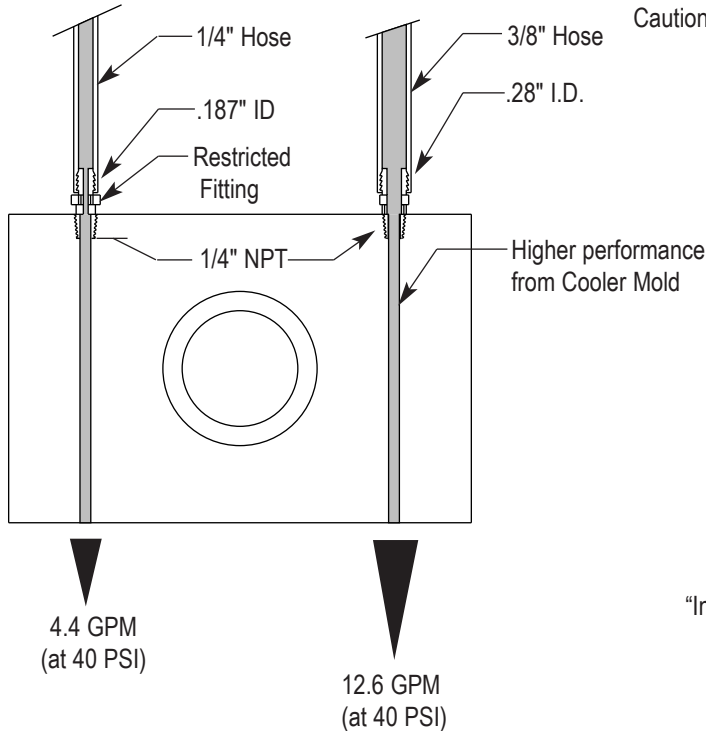

Caution: Unbalanced flow will result from change in flow direction.

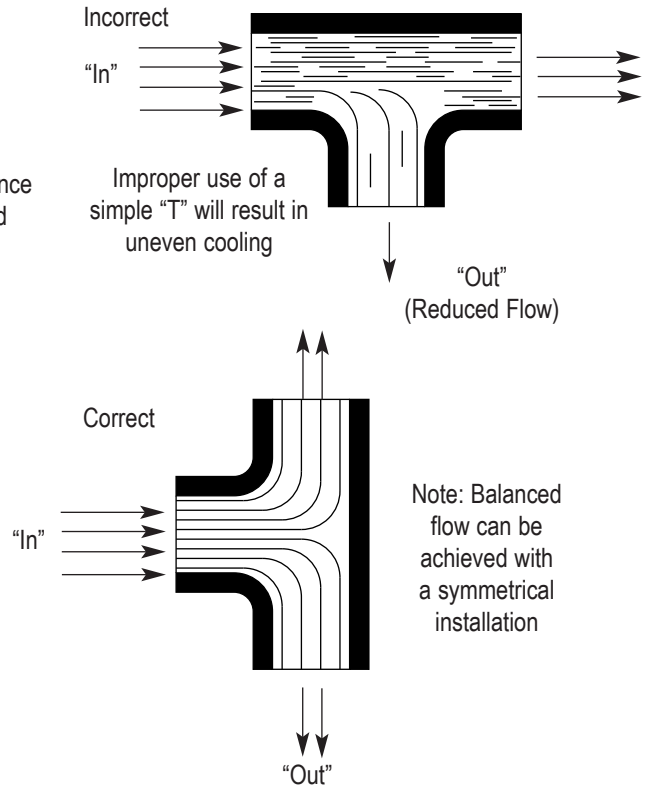

200% More Flow Area with High Flow Fittings

A mold will always be limited by its least cooled cavity. Coolant supply area should always be more than total mold ports area to avoid starving the mold of pressure and flow. Pressure difference across the mold should be no less than 40 P.S.I.

Avoid kinked hoses and any other restrictions.

Hose I.O.	Fitting Orifice Size	Area Square Inch	Supply area should exceed total of outlets (area square inch)						
			2 Ports	4 Ports	6 Ports	8 Ports	10 Ports	12 Ports	16 Ports
1/4"	.19"	.03	.06"	.12	.18	.24	.30	.36	.48
3/8"	.28"	.06	.12"	.24	.36	.48	.60	.72	.96
1/2"	.40"	.12	.24"	.48	.72	.96	1.20	1.44	1.92
3/4"	.56"	.25	.50"	1.0	1.50	2.00	2.50	3.00	4.00
1"	.87"	.59							
1-1/4"	1.0"	.78							
1-1/2"	1.25"	1.23							
2"	1.88"	2.7							

Example:
Supply 1" .59 sq. inch
3/8" waterlines = .06 square inches
.56 divided by .06 = up to 9 waterlines

Note: supply .48 sq. in. exceeds total hold cooling channel area

A typical mold with 8 (3/8) cooling circuits can be supplied with a 1" manifold.

CITO-FP-PRICE-20-1023